



3101121 OPTIONAL HEAT PACKAGE INSTALLATION INSTRUCTIONS

MODEL SERIES: 579XX, 590XX & 59516 (60XXXX, 61XXXX ON PAGE 2)
ALL MODELS ARE PREWIRED WITH A POWER RECEPTACLE IN THE
ELECTRIC BOX FOR EASY INSTALLATION

PRECAUTIONS:

⚠ WARNING

Improper installation may damage equipment, could endanger life, cause serious injury and/or property damage.

- Read Installation and Operating Instructions carefully before attempting to start your air conditioner.
- The Dometic Corporation will NOT be liable for any damages or injury incurred due to failure in following these instructions.
- The installed air conditioner and heat kit must be serviced by qualified personnel and some States require these people to be licensed.
- Read and understand these instructions before attempting to install the Heat Kit.

⚠ WARNING

The electrical power supply to the air conditioner must be "OFF" during the installation of this heat kit. Failure to follow this instruction may create a shock hazard.

⚠ WARNING

This accessory heat kit connects to an appliance that is equipped with a 3-wire (grounded) system for protection against shock hazards. Make sure that the appliance is wired into a properly grounded 115 volt AC circuit and that the polarity is correct before installation of this kit. Failure to do so could result in death, injury or damage to the equipment.

If the air conditioner is currently installed, remove the air box per Paragraph A.

If the heater is being installed during the air conditioner installation, install the heater per Paragraph B **"Before the Air Box is Installed"**.

⚠ WARNING

The main power supply to the unit must be OFF for safety from electric shock.

A. AIR BOX REMOVAL (when air conditioner is currently installed)

1. Remove the return air grill.
2. Remove the hole plug at the rear of the air box (held by friction pins).
3. Remove four wood screws "B" around outside of box (if installed).
4. Remove three screws "C" from center section of box.
5. Remove air box.

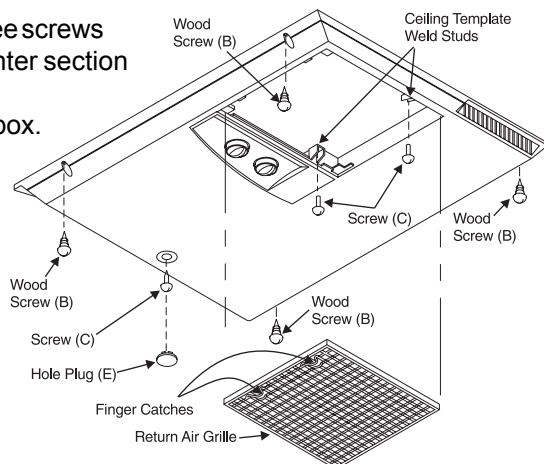

B. HEATER INSTALLATION

1. Install heat package to ceiling template using two metal screws provided. The heater element will align **directly** below the discharge air opening when located correctly.

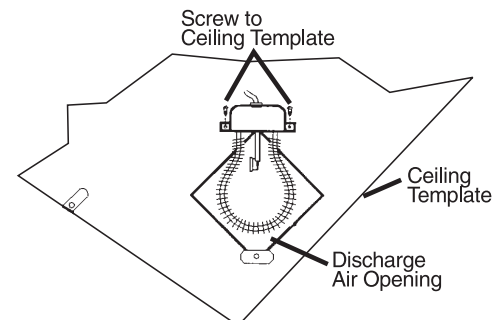

2. Push the three position electric heater connector into the mating three position connector on the electric box.
3. If you have a Dometic Electronic Comfort Control Kit installed to control your air conditioner, go to the instructions on the configuration of that system in Section D. If you have a Dometic Analog Control Kit (Part Number 3107541.017) installed to control your air conditioner, see the instructions for that system in Section E.

REVISION

Form No. 3103833.061 12/99
(Replaces 3103833.053)
(French 3108107.016)

©1999 The Dometic Corporation
LaGrange, IN 46761

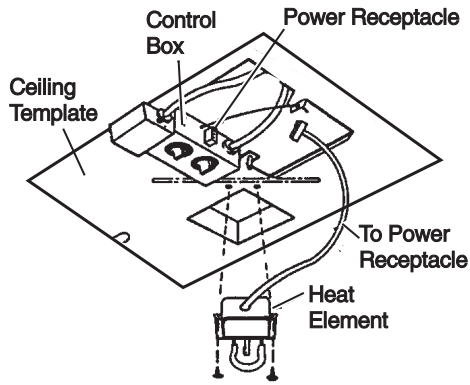

C. AIR BOX INSTALLATION

1. The air box is notched. Slit the insulation and foil tape or plastic knockout where the power cord goes through the air box.
2. Slide the air box up to the ceiling template.
3. Secure with the seven screws (refer to the air conditioner installation instructions).
4. Install the hole plug.
5. Install the return air grill.
6. Turn on the power and check operation per the air conditioner installation and operating instructions.

3101121 OPTIONAL HEAT PACKAGE INSTALLATION INSTRUCTIONS

**MODEL SERIES: 60XXXX, 61XXXX (579XX, 590XX & 59516 ON PAGE 1)
ALL MODELS ARE PREWIRED WITH A POWER RECEPTACLE IN THE
ELECTRIC BOX FOR EASY INSTALLATION**

PRECAUTIONS:

⚠ WARNING

Improper installation may damage equipment, could endanger life, cause serious injury and/or property damage.

- Read Installation and Operating Instructions carefully before attempting to start your air conditioner.
- The Dometic Corporation will NOT be liable for any damages or injury incurred due to failure in following these instructions.
- The installed air conditioner and heat kit must be serviced by qualified personnel and some States require these people to be licensed.
- Read and understand these instructions before attempting to install the Heat Kit.

⚠ WARNING

The electrical power supply to the air conditioner must be "OFF" during the installation of this heat kit. Failure to follow this instruction may create a shock hazard.

⚠ WARNING

This accessory heat kit connects to an appliance that is equipped with a 3-wire (grounded) system for protection against shock hazards. Make sure that the appliance is wired into a properly grounded 115 volt AC circuit and that the polarity is correct before installation of this kit. Failure to do so could result in death, injury or damage to the equipment.

If the air conditioner is currently installed, remove the air box per Paragraph A.

If the heater is being installed during the air conditioner installation, install the heater per Paragraph B. **"Before the Air Box is Installed"**.

⚠ WARNING

The main power supply to the unit must be OFF for safety from electric shock.

A. AIR BOX REMOVAL (when air conditioner is currently installed)

1. Remove filter/grill assembly by placing fingers on long portion of latches and with an over-and-downward pressure, unlatch the catches.
2. a) **Electronic Models:** Disconnect cables.
b) **Mechanical Models:** Remove knobs.

3. Remove four screws.
4. Remove box.

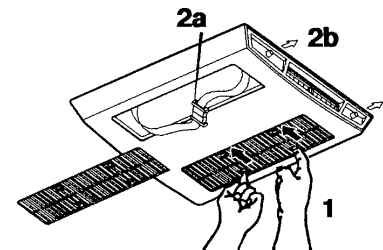

B. HEATER INSTALLATION

1. Install heat package to ceiling template using two sheet metal screws provided. The heater element will align **directly** below the discharge air opening when located correctly.

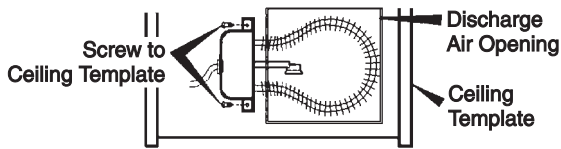

2. Push the heater electric connector into the back of the mating connector on the electric box.
 - a) **Electronic Control:** The cord routes over the ceiling template to the junction box (left side).
 - b) **Mechanical Control:** The cord routes directly into the right side switch box.

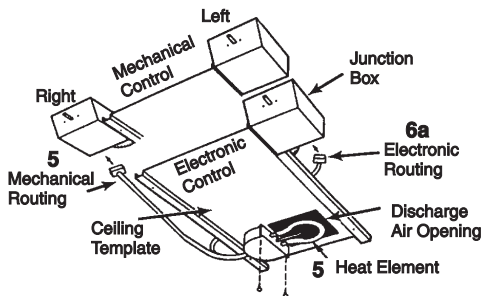

C. GUARD INSTALLATION

⚠ WARNING

The guard must be installed to prevent shock hazard to the user.

1. Remove the screw at the back center of the ceiling template, holding the return air duct.
2. Install the guard 1/2" from the ceiling template left channel with the same screw (through the grill as shown).

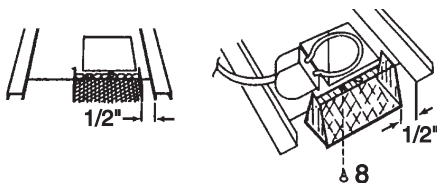

3. If you have a Dometic Electronic Comfort Control Kit installed to control your air conditioner, go to the instructions on the configuration of that system in Section E. If you have a Dometic Analog Control Kit (Part Number 3107541.017) installed to control your air conditioner, see the instructions for that system in Section F.

D. AIR BOX INSTALLATION

1. Remove the knockout in the air box wall. The insulation is pre-cut. (**DO NOT remove any. It is necessary for a seal.**)
2. Slide the air box into place (over the switch knobs if you have a mechanical control unit and then . . .) over the heater and guards.
3. Secure the four screws through the air box legs into the ceiling template (refer to the air conditioner Installation Instructions).
4.
 - a) **Electronic Controls:** Reconnect the cables.
 - b) **Mechanical Controls:** Reinstall the knobs.
5. Snap the grills into place.
6. **TURN ON THE POWER** and check operation per the air conditioner Installation and Operating Instructions.

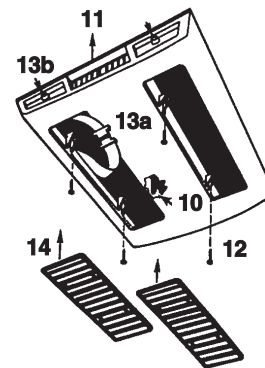

E. COMFORT CONTROL CENTER CONFIGURATION FOR ELECTRIC HEAT KIT

⚠ WARNING

Ensure all 115 Volt AC and 12 Volt DC power is shut off.

1. Locate **Electronic Control Box**.
2. Remove access cover to expose dip switches. NOTE: The Electronic Control Box is factory shipped with dip switches in the "OFF" position.
3. Place dip switch #1 Heat Strip to "ON" position.
4. Replace access cover.
5. Turn on electrical power to the air conditioner.

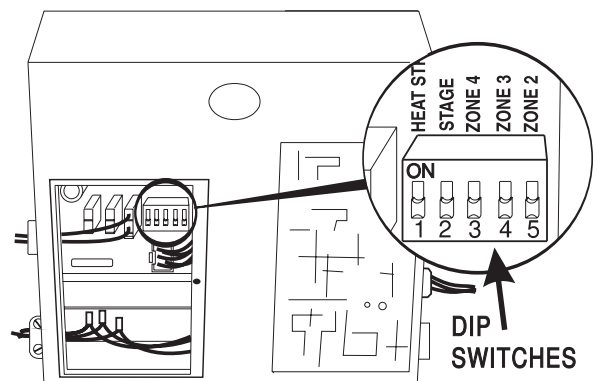

6. **SYSTEM CHECKOUT AND CONFIGURATION**

Now that the system is installed, it is necessary to reset the Comfort Control Center and check out the system. Refer to the Operating Manual for a description of the air conditioner operation.

a. **RESET COMFORT CONTROL CENTER:**

1. Turn control on to insure annunciator data and light are present. If data and light are present, continue with next step.
2. Press mode switch to activate annunciator light.
3. Simultaneously press the bottom two buttons (Temperature up and down) and hold.
4. While holding these buttons down, press the mode button once and release.
5. Release the two buttons previously held down
6. Depress the mode button once again.
7. At this time the light should extinguish and the mode should register "OFF". If not, repeat steps 2 through 6.

b. **SYSTEM CHECKOUT:** Verify that all features of the installed system work. Check fan speeds, cooling mode, heat pump mode, furnace (if connected) and heat strip. If the features do not work, check all wiring and confirm that the correct options have been selected on the Electronic Control Box. (See Comfort Control Center™ Operating Instructions).

c. Return to Step C for 579XX, 590XX and 59516 instructions. For Models 60XXXX and 61XXXX, refer to Step D Air Box Installation.

F. **ANALOG CONTROL HEAT STRIP INSTALLATION**



Ensure all 115 Volt AC and 12 Volt DC power is shut off.

1. Locate the 3107541.017 Analog Control Box.
2. Route the heater three position connector to its matching outlet on the Analog Control Box.

Note: The electric heat kit will not be accepted for use with the 3107541.009 cooling furnace or the 3107541.027 cooling, furnace and heat pump controls.

3. Return to Step C for 579XX, 590XX and 59516 instructions. For Models 60XXXX and 61XXXX refer to Step D - Air Box Installation.